

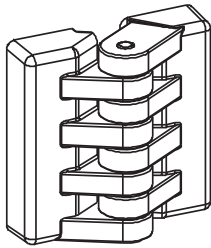

V :1

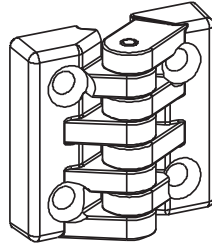

V :2



1199

ПЛОСКАЯ ПЕТЛЯ



- Доступны версии с болтом или без болта
- Штифт из нержавеющей стали

МАТЕРИАЛ

КОРПУС:
Полиамид PA 6 GFR 30

ШТИФТ:

Нержавеющая сталь

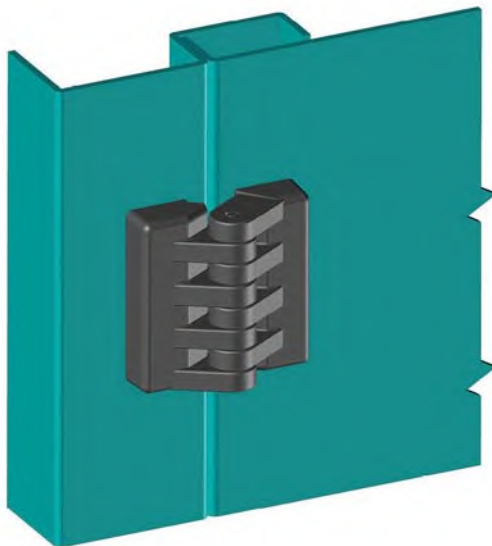
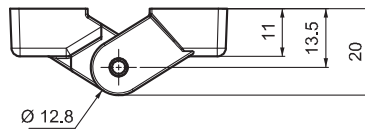
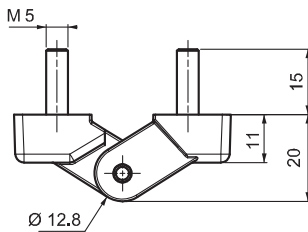
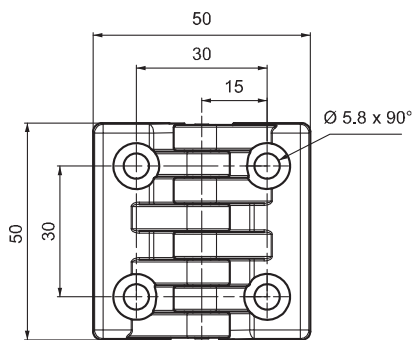
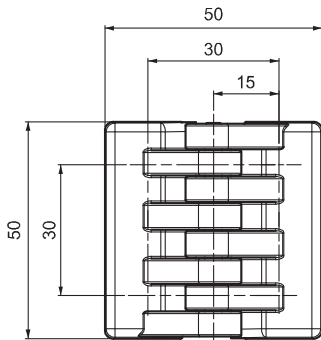

КОД ИЗДЕЛИЯ



МАТЕРИАЛ	M	ПОКРЫТИЕ	F
Полиамид	2	Без покрытия	0

Угол поворота петли

